

TrailerTail[®]

BY STEMCO

Secondary Cable Latch

Installation Manual

Revision 1.0; Updated: January 12, 2018

Table of Contents

03 Installation Tool List

04 Secondary Cable Latch Installation

04 TrailerTail® 4x4 – Cross-over Cable Latch

05 TrailerTail® Trident – Dual Cable Latch

Installation Tool List

Installation of a secondary cable latch will require the following tools:

- Rivet gun for 1/4" rivets
- Power drill
- 17/64" drill bit
- Tape measure

Secondary Cable Latch Installation

TrailerTail® 4x4 – Cross-over Cable Latch

1. Mark and drill two $17/64$ " holes for the Footman Loops on both the roadside and curbside lateral panels.

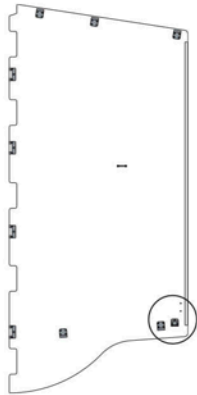

TrailerTail® 4x4
Curbside Lateral Panel

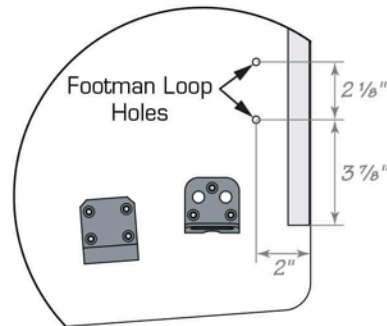

Footman Loop
Hole Dimensions

If a conversion template is provided, place it as shown to locate the Footman Loop holes.

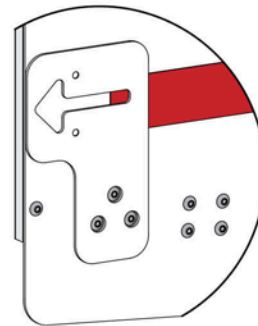

Cross-over Cable Latch
Conversion Template

2. Place the closed-loop end of the cable around the Footman Loop. Insert the rivets from the outside of the panel. Rivet the Footman Loop on the inside face (towards the trailer door) of the **curbside** lateral panel.
3. Insert the rivets from the inside of the panel and rivet another Footman Loop to the outside face of the **roadside** lateral panel.

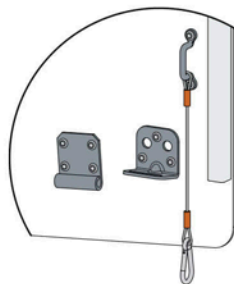

Inside of Curbside
Lateral Panel

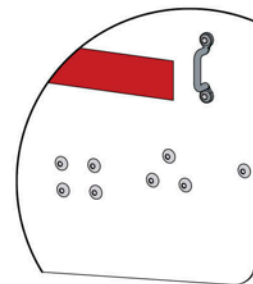

Outside of Roadside
Lateral Panel

4. Secure the panels closed by clipping the snap hook on to the Footman Loop of the roadside lateral panel.

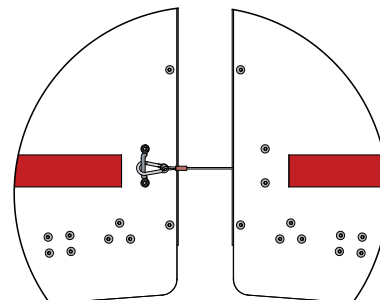

Securing Panels Closed

TrailerTail® Trident – Dual Cable Latch

1. Select the install location of the secondary cable latch.

Intermodal Trailers – Location A

A cable latch is required in the higher install location, A, for trailers traveling intermodal (via rail) to secure the TrailerTail® closed as tight as possible.

LCV with AutoDeploy™ Trailers – Location B

A cable latch is required for trailers traveling in a Long-Combination Vehicle configuration (LCV) when equipped with AutoDeploy™ to prevent the TrailerTail® on the front trailer from automatically deploying at speed. The lower install location, B, is preferred to allow the driver to quickly secure or release the cable latch.

General Use Trailers – Location B

A cable latch is discouraged from general use but may be installed upon request. The lower install location is preferred to allow the driver to quickly secure or release the cable latch.

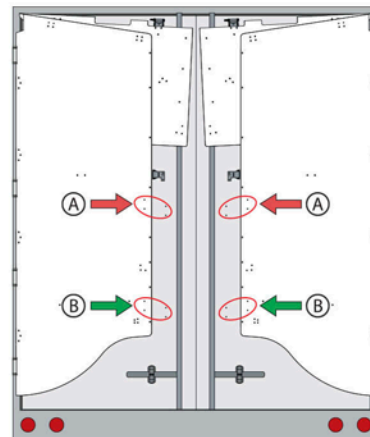

2. Mark and drill two $17/64$ " holes for the Footman Loops on both the roadside and curbside lateral panels. Close both lateral panels and mark the location of the two Footman Loop holes on the door using the measurements in the image below. Use a $1/4$ " drill bit to drill these holes.

Caution: For refrigerated trailers, be sure to only drill through the outer trailer skin for the holes on the door. Do not puncture the insulating wall.

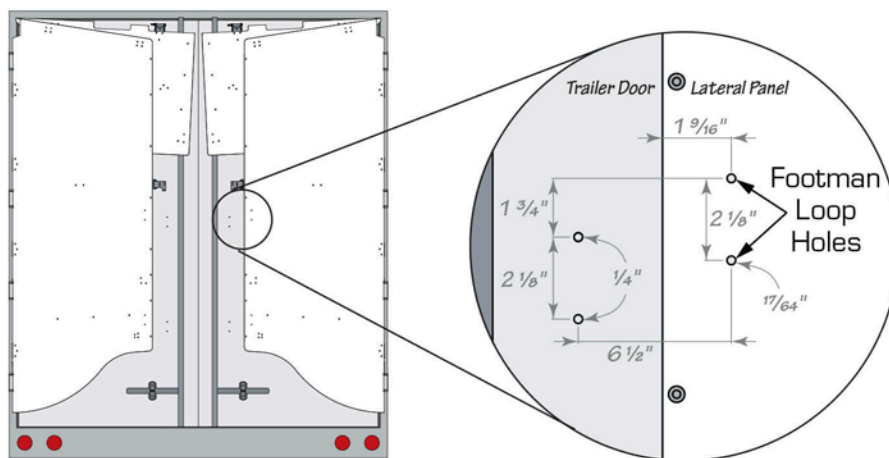

AutoDeploy Installation

TrailerTail® Trident – Dual Cable Latch

3. The hardware required to fasten the Footman Loop to the door will depend on the trailer type. Additionally, there are two methods for installing the cable latch.

For Dry Van Trailers:

Method A – Cable on Lateral Panel

- Attach the end of the cable with the solid loop around one Footman Loop.
- Rivet this Footman Loop to the pre-drilled holes on the inside of the lateral panel using two aluminum, Ornit rivets. Insert the rivets from the **outside** of the panel.
- Attach a second Footman Loop to the door with 1/4" carriage bolts and lock nuts.

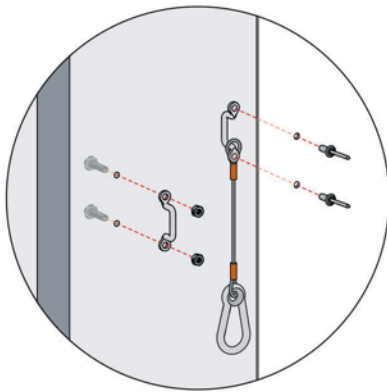

Method A

Cable Riveted to Backside of Lateral Panel

Method B – Cable on Door

- Rivet a Footman Loop to the pre-drilled holes on the outside of the lateral panel using two aluminum, Ornit rivets. Insert the rivets from the **inside** of the panel.
- Attach the end of the cable with the solid loop around another Footman Loop.
- Attach this second Footman Loop to the door with 1/4" carriage bolts and lock nuts.

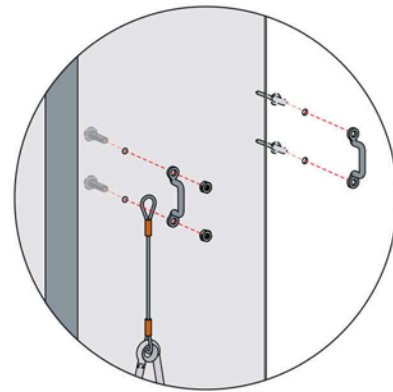

Method B

Cable Attached to Door

TrailerTail® Trident – Dual Cable Latch

For Refrigerated Trailers:

Method A – Cable on Lateral Panel

- Attach the end of the cable with the solid loop around one Footman Loop.
- Rivet this Footman Loop to the pre-drilled holes on the inside of the lateral panel using two aluminum, Ornit rivets. Insert the rivets from the **outside** of the panel.
- Attach a second Footman Loop to the door with Bulb-Tite rivets.

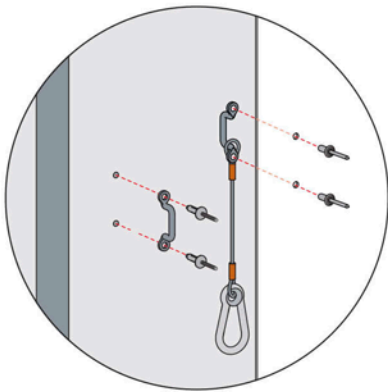

Method A

Cable Riveted to Backside of Lateral Panel

Method B – Cable on Door

- Rivet a Footman Loop to the pre-drilled holes on the outside of the lateral panel using two aluminum, Ornit rivets. Insert the rivets from the **inside** of the panel.
- Attach the end of the cable with the solid loop around another Footman Loop.
- Attach this second Footman Loop to the door with Bulb-Tite rivets.

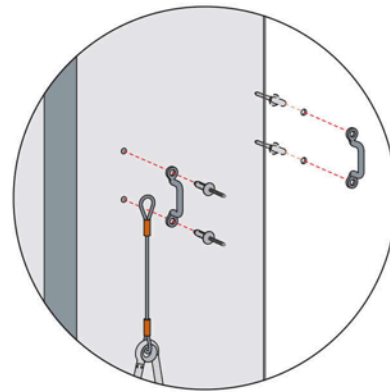

Method B

Cable Attached to Door



For more information visit www.stemco.com/trailertail or call 1-888-283-TAIL.

STEMCO USA – 300 Industrial Blvd. • Longview, Texas 75602 • (903) 758-9981 • 1-800-527-8492 • FAX 1-800-874-4297

STEMCO Mexico – Col. COLTONGO, México D.F • MEXICO C.P. 02630 • 011-52-53-68-26-37

STEMCO Canada – 5775 McLaughlin Road • Mississauga, ON L5R 3P7 • (905) 206-9922 • (877) 232-9111 • FAX (877) 244-4555

Printed in U.S.A. ISO 16949 STEMCO and TrailerTail are trademarks of STEMCO LP. © 2018 Part Number: ATD004032 01/18